

Surgical Technique



Acumed® is a global leader of innovative orthopaedic and medical solutions.



We are dedicated to developing products, service methods, and approaches that improve patient care.



Acumed® Fibula Nail 2 System

Designed in conjunction with Roy Sanders, MD, the Acumed Fibula Nail 2 includes three nail diameters and four length options, power reamers and carbon fiber radiolucent targeting guides to streamline the procedure, threaded holes within the nail, headless hexalobe screws to minimize soft-tissue irritation, and the option to lock the nail proximally, providing additional fixation within the canal.

The Fibula Nail 2 must be used in conjunction with the Acumed Fibula and Forearm Nail (FFN) 2 Base Set, which contains universal instrumentation to implant the Fibula Nail 2, Ulna Nail 2, and screws.

Indications for Use:

The Acumed Fibula and Forearm Nail 2 System, consisting of Fibula Nail 2 and Ulna Nail 2 implants and instruments, is intended for fixation of fractures and osteotomies of the fibula and ulna respectively, including fractures where the medullary canal is narrow or flexibility of the implant is paramount.

	Definition
Warning	Indicates critical information about a potential serious outcome to the patient or the user.
Caution	Indicates instructions that must be followed in order to ensure the proper use of the device.
Note	Indicates information requiring special attention.



Table of Contents

Fibula Nail 2 System Features	2
Acu-Sinch® Knotless Ankle Syndesmosis Repair System Features	6
Surgical Technique	7
Fibula Nail 2 Surgical Technique	7
Fibula Nail 2 Removal Technique	23
Acu-Sinch Knotless Ankle Syndesmosis Repair System Surgical Technique	26
Ordering Information	29

Fibula Nail 2 System Features

Comprehensive System

The Acumed Fibula Nail 2 is designed to address simple, transverse, and short oblique fractures as well as osteotomies of the fibula.

The Fibula Nail 2 includes:

- ▶ 12 nails offered in three diameters and four lengths including a small 2.6 mm diameter
- ▶ 5° bend in the nail designed to accommodate the shape of the intramedullary canal
- ▶ Power reamers and carbon fiber radiolucent targeting guides to streamline the procedure
- ▶ Threaded holes within the nail that engage with the interlocking screws
- ▶ Two A/P and two L/M hole options
- ▶ L/M holes angled 8° superior to avoid the joint space and allow for syndesmotomic reduction
- ▶ Headless hexalobe screws aim to minimize soft-tissue irritation
- ▶ Option to lock the nail proximally, providing additional fixation within the canal

The Fibula Nail 2 must be used in conjunction with the Acumed Fibula and Forearm Nail 2 Base Set, which contains universal instrumentation to implant the Fibula Nail 2, Ulna Nail 2 and screws.

Note: All nail tail diameters are 6.35 mm

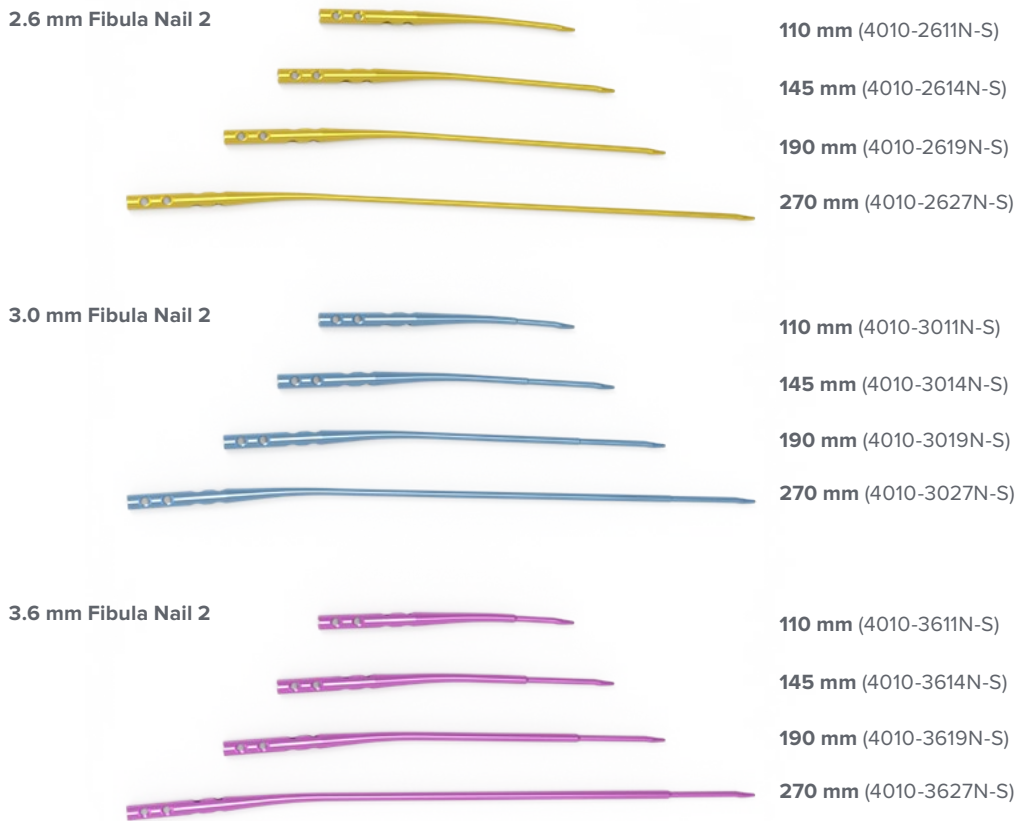

Fibula Nail 2 implants accept:

- ▶ 3.5 mm Headless Hexalobe Screws
- ▶ 3.5 mm Nonlocking Hexalobe Screws

Indications for Use

The Acumed Fibula and Forearm Nail 2 System is intended for fixation of fractures and osteotomies of the fibula and ulna, including fractures where the medullary canal is narrow or flexibility of the implant is paramount.

Fibula Nail 2 System Features [continued]

Implant Features

Nail Bend

The nail's 5° bend is designed to accommodate the shape of the intramedullary canal

Optional Tip-Loc™ Technology

The Tip-Loc Bushing and Set Screw offers the option to lock the nail proximally, providing additional fixation within the canal.

Low-Profile Screws

3.5 mm headless hexalobe screws are low-profile and are intended to minimize soft-tissue irritation

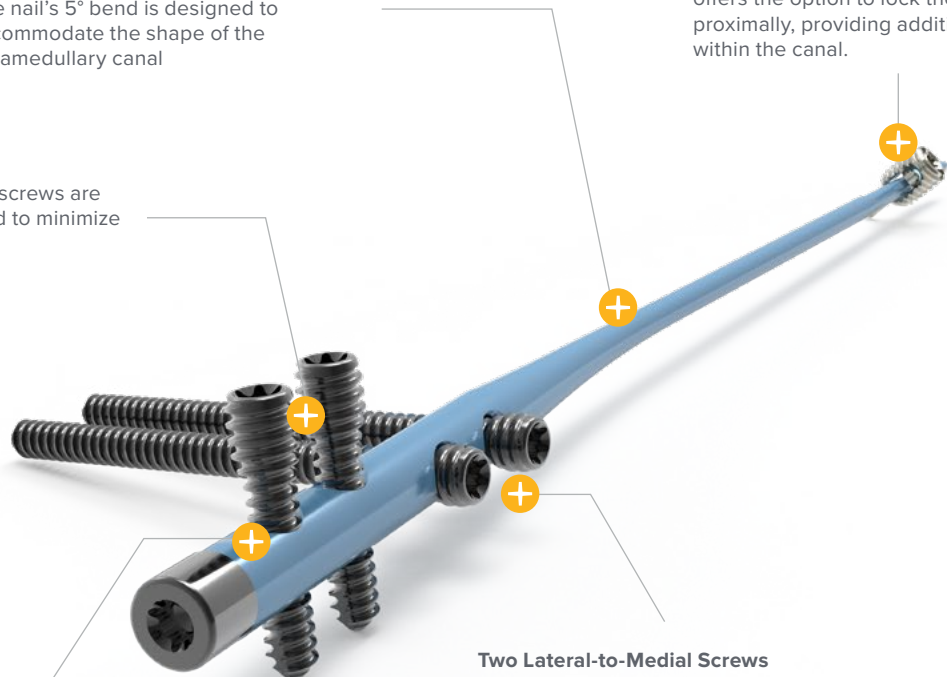

Two Lateral-to-Medial Screws

The most proximal screw hole is threaded to create a locking construct to provide additional fixation when desired. Both screw trajectories follow the natural inclination of the tibiotalar joint, and can be used for syndesmotomic fixation

Fixed-Angle Screw Holes

Two threaded anterior to posterior fixed-angle screw holes

Screws

3.5 mm Nonlocking Hexalobe (8–65 mm) and 3.5 mm Headless Hexalobe (12–65 mm) Screws are both included in the system.

The 3.5 mm Headless Hexalobe screws lock into the threaded holes within the nail and are intended to create a low-profile construct to minimize soft-tissue irritation.



Optional End Caps

End caps are offered in +0.4 mm, +5 mm, +10 mm, and +15 mm lengths and thread into the tail of the fibula nail. End caps assist in limiting ossification over the end of the nail, making the nail threads easier to engage if removal is desired. End caps also allow surgeons to create an intermediate nail length while adjusting for anatomic variances and screw trajectories.



Fibula Nail 2 System Features [continued]

The Fibula Nail 2 nails are delivered in sterile packaging and are designed to be used in conjunction with the Fibula and Forearm Nail 2 Base Set. This set includes shared instrumentation to implant the Fibula Nail 2, Ulna Nail 2, and screws.

Reamers

Reamers are included in the system to provide a single step in which to measure for both nail length and diameter. The reamers may be used by hand or under power to optimize operative time.



Reamer	Nail Diameters
FFN 2.7 mm Reamer (80-2459)	2.6 mm Fibula Nail 2 (4010-26XXN-S)
FFN 3.1 mm Reamer (80-2460)	3.0 mm Fibula Nail 2 (4010-30XXN-S)
FFN 3.7 mm Reamer (80-2461)	3.6 mm Fibula Nail 2 (4010-36XXN-S)

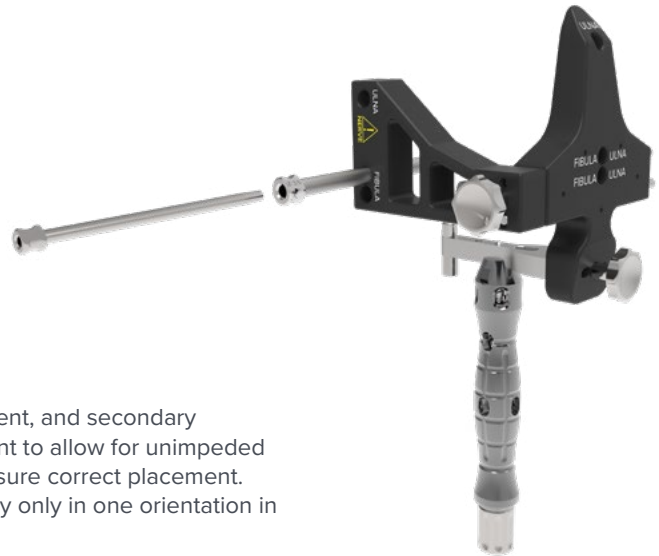

Radiolucent Carbon Fiber Targeting Guides

Both the primary targeting guide, which aids in L/M screw placement, and secondary targeting guide, which aids in A/P screw placement, are radiolucent to allow for unimpeded viewing of the nail and screw positioning under fluoroscopy to ensure correct placement. The targeting guide components were designed to allow assembly only in one orientation in order to simplify the process for the scrub tech.

Removal Instruments

A variety of instruments to aid in both implant and screw removal are included in the system. The FFN Bolt (80-3886), 2.0 mm Easyout, QR (80-0599), and 3.0 mm Easyout, QR (80-0601) provide multiple options to remove the screws or fibula nail if necessary.



FFN Bolt
(80-3886)



2.0 mm Easyout, QR
(80-0599)



3.0 mm Easyout, QR
(80-0601)

Fibula Nail 2 System Features [continued]

Optional Tip-Loc™ Bushing & Set Screw Kit

The Fibula Nail 2 offers the option to lock the nail proximally, providing additional fixation within the canal.

The Tip-Loc Bushing and Tip-Loc Set Screw sit centrally within the last 1.5" of the nail. These sterile packed implants are offered in 1 mm increments ranging from 6 mm through 16 mm in length.



Tip-Loc Bushing

- ▶ Titanium
- ▶ 6.35 mm in diameter



Tip-Loc Set Screw

- ▶ Cobalt Chrome
- ▶ 3.4 mm in diameter
- ▶ Implanted using FFN T8 Driver
- ▶ Sterile-packed with corresponding bushing size

Tip-Loc™ Bushing & Set Screw Kit	Part number
Tip-Loc Bushing & Set Screw Kit, 6 mm	47-0006-S
Tip-Loc Bushing & Set Screw Kit, 7 mm	47-0007-S
Tip-Loc Bushing & Set Screw Kit, 8 mm	47-0008-S
Tip-Loc Bushing & Set Screw Kit, 9 mm	47-0009-S
Tip-Loc Bushing & Set Screw Kit, 10 mm	47-0010-S
Tip-Loc Bushing & Set Screw Kit, 11 mm	47-0011-S
Tip-Loc Bushing & Set Screw Kit, 12 mm	47-0012-S
Tip-Loc Bushing & Set Screw Kit, 13 mm	47-0013-S
Tip-Loc Bushing & Set Screw Kit, 14 mm	47-0014-S
Tip-Loc Bushing & Set Screw Kit, 15 mm	47-0015-S
Tip-Loc Bushing & Set Screw Kit, 16 mm	47-0016-S



Tip-Loc Clamp
(80-3891)

The Tip-Loc Bushing is implanted using the Tip-Loc Clamp, a Near Cortex Drill, and a Far Cortex Drill. The Tip-Loc Clamp is entirely radiolucent to aid in visualization under fluoroscopy and includes a central cannula that allows for +/- 2 mm of adjustment, to center and align the bushing with the nail tip.



FFN Near Cortex Drill
(80-3696)



FFN Far Cortex Drill
(80-3697)

Acu-Sinch® Knotless Ankle Syndesmosis Repair System Features

The Acu-Sinch Knotless Implant enables the dynamic stabilization of syndesmotic disruptions to the tibiofibular joint. The Acu-Sinch Knotless buttons may be augmented with a washer or may be used in conjunction with the Acumed and OsteoMed fibula fracture fixation plates and intramedullary nails with 3.5 mm nonlocking screw holes. Our patented release mechanism gives the user control to place the medial button subcutaneously without the need for direct visualization.

Acu-Sinch Knotless can be utilized in the distal non-threaded L/M hole in the Fibula Nail 2.

Acu-Sinch® Knotless System 3.5 mm



Low-profile titanium Round Button is compatible with a variety of titanium fibula plates with 3.5 mm nonlocking screw holes

Self-locking suture loop made from #2 UHMWPE nonabsorbable HS Fiber enables an adjustable knotless repair

Titanium Flip Button is designed to pass through a 3.5 mm bone tunnel, plates, or intramedullary nails with a nonlocking 3.5 mm hole

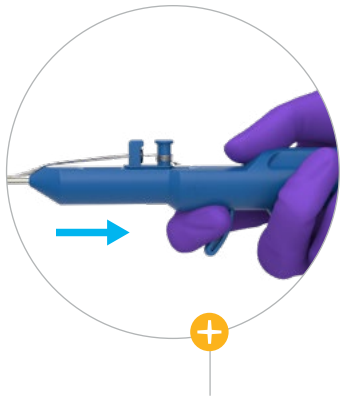

Spring-loaded trigger for one-step Flip Button delivery



Suture carriage automatically ejects from the handle during deployment

Patented Flip Button design obviates the need for a medial incision



The Acu-Sinch Knotless System is provided on a disposable inserter handle preassembled and sterile packaged

Acu-Sinch Washer 3.5 mm

Slotted titanium washer is designed for assembly over the suture after the Acu-Sinch Knotless has been deployed, for increased surface area on the bone



A 3.5mm Long Drill provides straightforward, single-step drilling to implant Acu-Sinch Knotless through the Fibula Nail 2

Fibula Nail 2 Surgical Technique

Figure 1

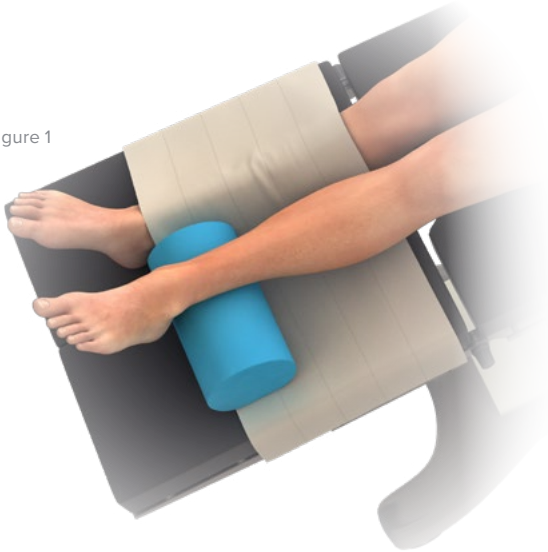

Figure 2

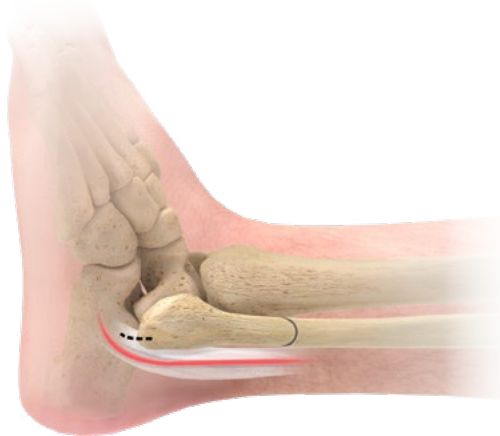
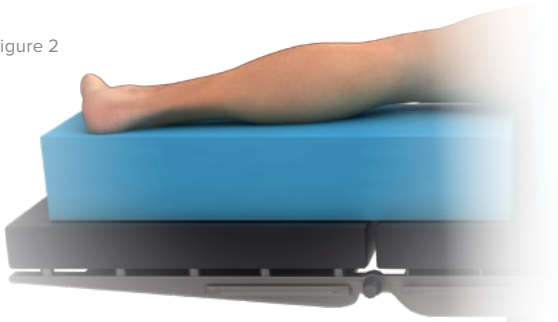

Figure 3

1 Preoperative Planning and Evaluation

Evaluate the location and characteristics of the fracture(s) using fluoroscopy. Place the patient in either a supine or lateral position (Figures 1 and 2). A radiolucent table top is recommended so that fluoroscopy can be used throughout the procedure.

Note: If a supine position is used, elevate the hip to allow for easier positioning for fluoroscopy.

Note: Internal rotation of the leg aids in the targeting and visualization of the lateral to medial interlocking screws.

2 Incision & Entry Point

The fibular fracture can be reduced and fixed using an entirely percutaneous (closed) technique. Make a 10–15 mm longitudinal incision just distal to the tip of the fibula (Figure 3).

Note: A mini-open reduction can be performed with the use of reduction forceps before nail insertion by extending the incision proximally.

Warning: Care must be taken to avoid the peroneal tendons and sural nerve.

Fibula Nail 2 Surgical Technique [continued]

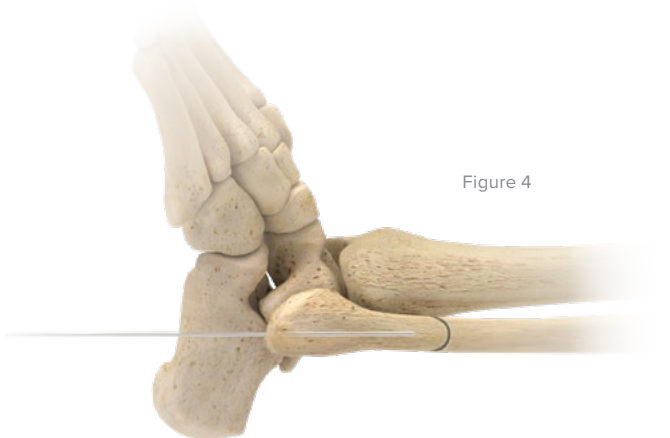

Figure 4

3 Fibula Canal Preparation

Insert the 2.0 mm x 9" ST Guide Wire (WS-2009ST) into the tip of the lateral malleolus under fluoroscopy. Advance the wire approximately 20–25 mm. Confirm under fluoroscopy that the guide wire is centrally located in both anterior-to-posterior (A/P) and lateral-to-medial (L/M) planes (Figure 4).

Note: As with any nail, the correct entry point is crucial. For example, an entry point that is too medial may result in a valgus shift at the fracture and lateralization of the malleolus and talus.

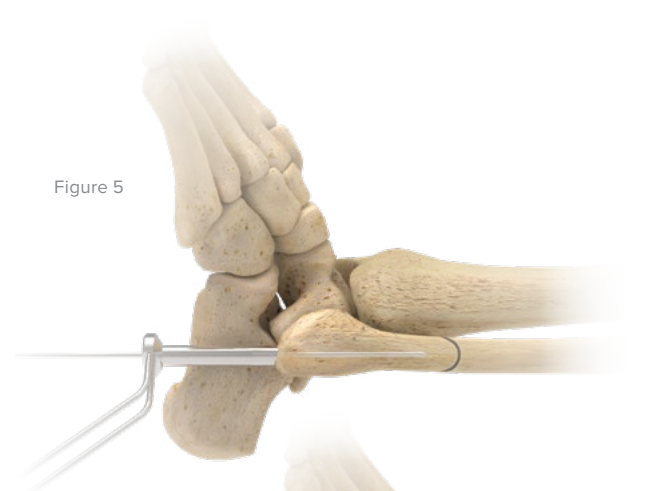

Figure 5

4 Nail Drilling

Slide the FFN Soft-Tissue Protector (80-2896) over the 2.0 mm x 9" ST Guide Wire (WS-2009ST) and ensure it is down to the bone surface (Figure 5). Place the cannulated FFN 6.5 mm Drill (80-4039) over the guide wire (Figure 6). Drill to the second depth mark, indicated by the letter "F0" (fibula zero) (Figure 7).

Note: The drill depth can also be confirmed under fluoroscopy by ensuring the fibula tip is aligned with the second notch on the drill.

Note: Care should be taken to sufficiently drill proximally so that the L/M, proximal screws pass safely above the tibial plafond.

Note: In larger patients, the nail may need to be inserted deeper within the metaphysis so that the proximal screws can clear the tibial plafond. To ensure the distal end of the nail still provides cortical support, an optional end cap can be used to extend the overall nail length. If using the optional FFN End Cap (4014-0XXX), drill with the FFN 6.5 mm Drill through the FFN Soft-Tissue Protector to the corresponding depth markings on the drill, indicated with "5", "10", and "F15." This will correspond to the proper FFN End Cap inserted in Step 12A.

Note: There is an optional Cortex Awl w/Quick Release (80-3795) that can help create an initial entry point prior to placing the 2.0 mm x 9" ST Guide Wire. The awl is not intended to be used through the FFN Soft Tissue Protector. Depth indicators found on the awl correspond with the surface of the bone. If using the optional FFN End Cap (4014-0XXX), engage the bone to the corresponding depth marking on the awl, labeled "F." This will correspond to the proper FFN End Cap inserted in Step 9.

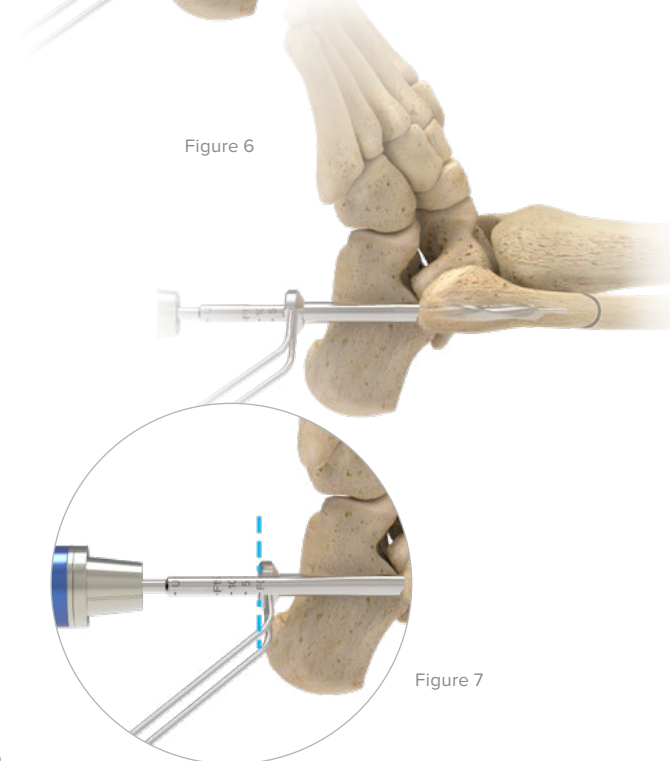

Figure 6

Figure 7

Fibula Nail 2 Surgical Technique [continued]

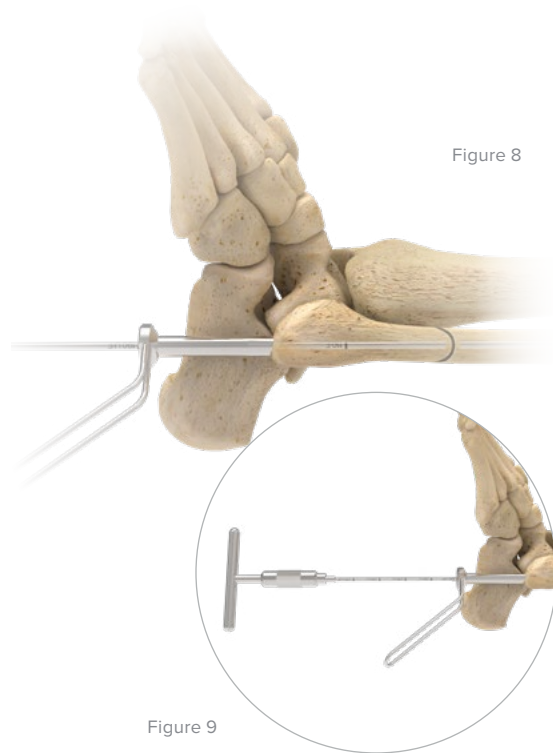

Figure 8

Figure 9

5 Canal Reaming

Remove the FFN 6.5 mm Drill (80-4039) and 2.0 mm x 9" ST Guide Wire (WS-2009ST). Ensure that the FFN Soft-Tissue Protector remains in place and is fully seated on the bone surface (Figure 8). Sequentially ream the intramedullary canal through the FFN Soft-Tissue Protector (80-2896), starting with the FFN 2.7 mm Reamer (80-2459), by hand using the Quick Release T-Handle (MS-T1212) or under power (Figure 9). Increase in diameter until the desired cortical engagement is achieved. Refer to the FFN Reamer Diameter table below:

FFN Reamer Diameter	Fibula Nail 2 Diameter
FFN 2.7 mm Reamer (80-2459)	2.6 mm Fibula Nail 2 (4010-26XXN-S)
FFN 3.1 mm Reamer (80-2460)	3.0 mm Fibula Nail 2 (4010-30XXN-S)
FFN 3.7 mm Reamer (80-2461)	3.6 mm Fibula Nail 2 (4010-36XXN-S)

Note: If resistance is met during reaming, retract slightly and re-advance and oscillate to allow the blunt tip of the reamer to center within the center of the canal.

Note: If reaming under fluoroscopy, take care to ensure the reamer is centered in the canal.

Fibula Nail 2 Surgical Technique [continued]

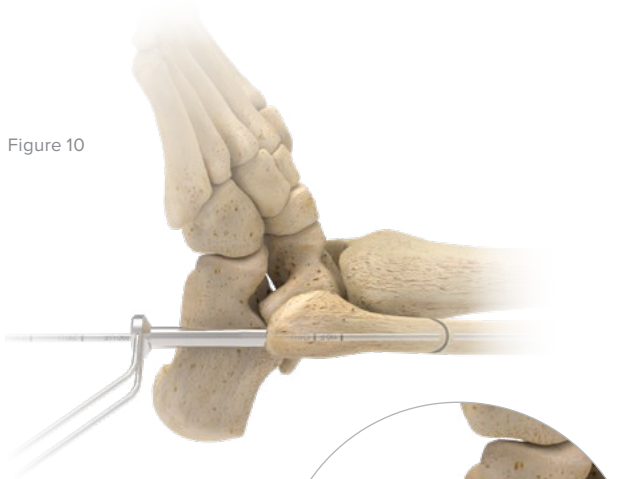

Figure 10

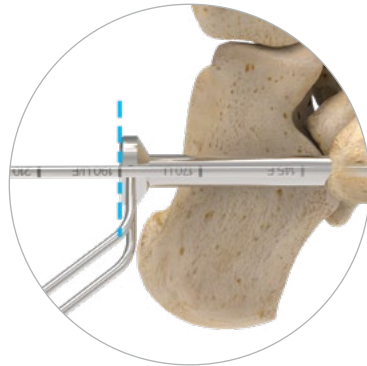

Figure 11

6 Fibula Nail Selection

Advance the FFN Reamer to the desired nail depth and leave the FFN Reamer and FFN Soft-Tissue Protector (80-2896) in place (Figure 10). The chosen reamer will determine the nail diameter selection.

FFN Reamer Diameter	Fibula Nail 2 Diameter
FFN 2.7 mm Reamer (80-2459)	2.6 mm Fibula Nail 2 (4010-26XXN-S)
FFN 3.1 mm Reamer (80-2460)	3.0 mm Fibula Nail 2 (4010-30XXN-S)
FFN 3.7 mm Reamer (80-2461)	3.6 mm Fibula Nail 2 (4010-36XXN-S)

With the FFN Reamer in place and the FFN Soft-Tissue Protector seated on the bone, read the laser mark on the FFN Reamer as it aligns with the back end of the FFN Soft-Tissue Protector cannula to determine the proper nail length (Figure 11). Once all nail size measurements have been recorded, remove reamer and FFN Soft-Tissue Protector from the canal.

Fibula Nail 2 Diameter	Fibula Nail 2 Length
2.6 mm Fibula Nail 2	110, 145, 190, 270 mm
3.0 mm Fibula Nail 2	110, 145, 190, 270 mm
3.6 mm Fibula Nail 2	110, 145, 190, 270 mm

Note: All Fibula Nail 2 tail diameters are 6.35 mm, regardless of the nail shaft diameter.

Warning: Choosing a nail that is too long may result in leaving the nail too proud. If between lengths, select the shorter of the two nails.

Fibula Nail 2 Surgical Technique [continued]

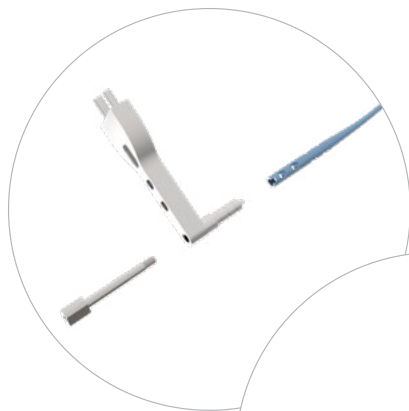

Figure 12

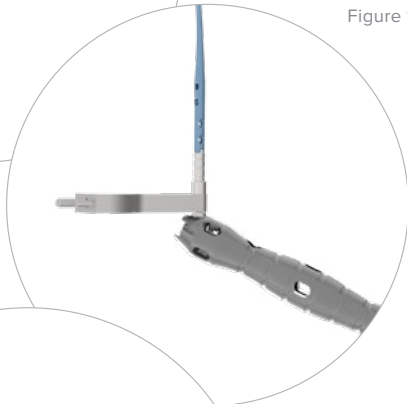

Figure 13



Figure 14



Figure 15

7 Fibula Nail to Base Plate Attachment

Place the FFN Locking Bolt (80-2452) through the barrel mount on the FFN Base Plate (80-2448). Line the fibula nail up with the alignment tab and use the FFN Locking Bolt to secure the nail to the FFN Base Plate (Figure 12). Securely tighten the FFN Locking Bolt by using any of the slots in the FFN Handle (80-3885).

Note: The FFN T15 Hexalobe Driver (80-3619) may also be used to tighten the locking bolt.

Note: The bow of the nail should angle toward the markings and the assembly posts on the base plate.

Optional: To attach the optional FFN Handle, insert the FFN Bolt (80-3886) into the FFN Handle and rotate clockwise until seated (Figure 14). Thread the combined FFN Bolt and FFN Handle into either of the threaded holes in the FFN Base Plate (Figure 13). The FFN Bolt has a retaining feature that prevents the bolt from falling out of the FFN Handle.

8 Targeting Guide Assembly

Attach the FFN Primary Targeting Guide (80-2454) to the FFN Base Plate (80-2448) by sliding the two posts on the base plate into the hole and slot of the FFN Primary Targeting Guide. Insert the FFN Locking Knob (80-2499) through the distal center hole of the FFN Primary Targeting Guide (Figure 15). Rotate the knob clockwise to tighten the FFN Primary Targeting Guide to the base plate.

Note: The posts of the FFN Base Plate only allow for one assembly orientation and are not side-specific.

Note: The FFN Primary Targeting Guide sits lateral to the fibula. The targeting assembly may be rotated slightly when placing screws across the syndesmosis.

Fibula Nail 2 Surgical Technique [continued]

Figure 16

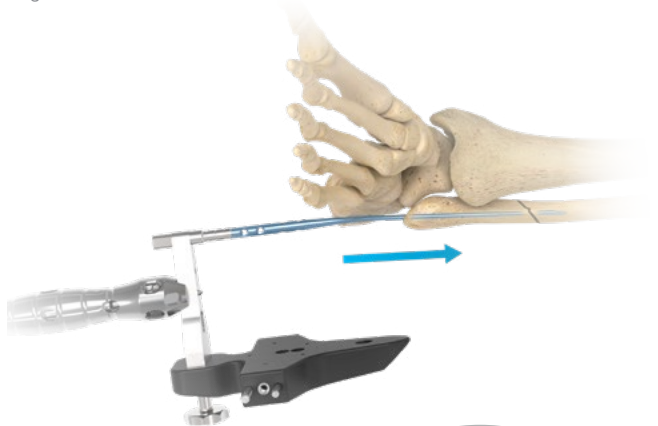

Figure 17

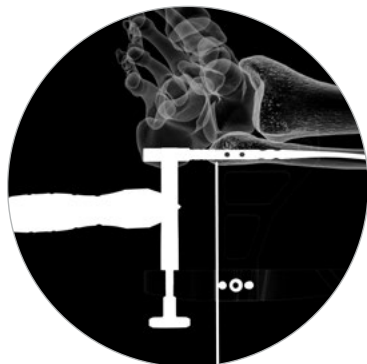
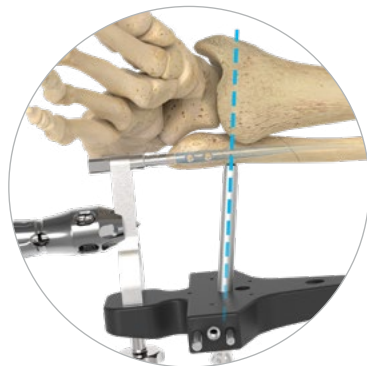

Figure 18

9 Nail Insertion and Positioning

Ensure the fracture is reduced and insert the selected fibula nail into the reamed bone (Figure 16). Insert the FFN 3.5 mm Cannula (80-2476) into the most distal targeting hole on the targeting guide, labeled "Fibula" (Figure 17).

An anterior-to-posterior (A/P) fluoroscopic view should be obtained to verify that the two proximal screw holes are above the tibial plafond and that the distal end of the nail has been inserted below the surface of the bone (Figure 18). Glide the nail tip past the fracture site and down to the distal metaphysis. The fibula nail should pass easily down the canal without impaction. If resistance is met, the nail should be withdrawn, and the canal checked again with the appropriate reamer.

The attached FFN Handle (80-3885) may be used to internally or externally rotate to ensure alignment. The handle may also be removed if desired.

Insert the 2.0 mm x 9" ST Guide Wires (WS-2009ST) through the targeting guide for additional stability; however they will need to be removed when retracting the fibula nail for optional Tip-Loc insertion in step 9C. The center-most distal K-wire hole identifies the junction of the fibula nail and the FFN Base Plate (80-2448).

Note: If using an optional FFN End Cap (4014-0XXX), locate the notches on the barrel section of the FFN Base Plate. These notches are viewable under fluoroscopy or direct visualization and indicate the approximate FFN End Cap length. Insert the nail to the desired depth and confirm the end cap length from the +0.4 mm, +5 mm, +10 mm, or +15 mm notch.

Optional FFN End Caps

FFN +0.4 mm End Cap	(4014-0600)
FFN +5 mm End Cap	(4014-0705)
FFN +10 mm End Cap	(4014-0710)
FFN +15 mm End Cap	(4014-0715)

Warning: Ensure that the screws will avoid the joint space.

Note: To use the optional Tip-Loc Bushing & Set Screw to lock the tip of the nail, allowing two points of fixation, continue to Step 9A. If not, proceed to Step 10.

Fibula Nail 2 Surgical Technique [continued]



Figure 19

9A Optional Tip-Loc™ Incision & Clamp Placement

With the fibula nail inserted to the correct depth, identify the nail tip, which narrows to 2.6 mm in diameter in the last 1.5" of the nail, under fluoroscopy and mark the center of that region on the skin. Use this mark as the center point for a 2–3 cm incision along the lateral fibula. Bluntly dissect around the fibula to make room for the clamp arms.

Assemble the Tip-Loc Rotary Cannula (80-3760) into the central hole of the Tip-Loc Clamp (80-3891) by aligning the insert/remove arrows with the arrow on the clamp. Once the cannula is engaged into the clamp, rotate it 180° in either direction until the arrow aligns with the 0 mm line (Figure 19).

Place the radiolucent clamp arms through the incision around the bone with the clamp handles proximal to the incision (Figure 20).

Note: It is recommended to place at least one of the two provided 2.0 mm Short Guide Wires (35-0023) through either K-wire hole near the clamp cannula into the bone to provide additional stability to the clamp.

Note: Care should be taken to ensure that the rotating cannula sits perpendicular to the long axis of the bone and flush on the bone.

Figure 20

Fibula Nail 2 Surgical Technique [continued]

Figure 21

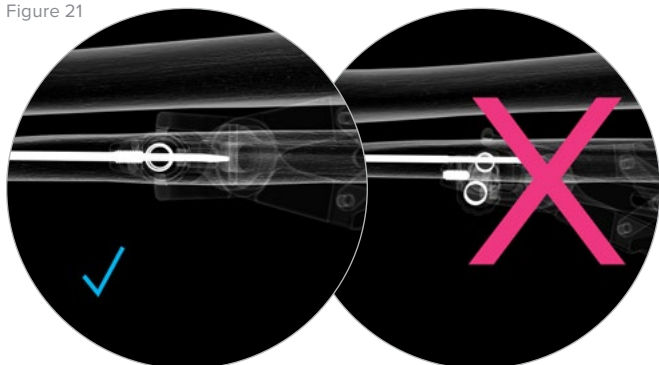

Figure 22

9B Optional Tip-Loc™ Fibula Nail Targeting

Under fluoroscopy, use the circle-circle technique to align the two radiopaque rings on the proximal and distal end of the rotating cannula within the Tip-Loc Clamp (80-3891) to provide visualization down the cannula (Figures 21 and 22).

If the tip of the fibula nail is not positioned in the center of the cannula, rotate the cannula in 1 mm increments until the tip of the nail is clearly centrally located within the two circles.

- ▶ **Clockwise Rotation** Shifts cannula right
- ▶ **Counterclockwise Rotation** Shifts cannula left

Figure 23



9C Optional Tip-Loc Drilling & Preparation

Once the tip of the fibula nail is targeted through the cannula within the Tip-Loc Clamp (80-3891), retract the fibula nail for subsequent drilling until the tip of the fibula nail is no longer visible through the cannula (Figure 23).

To drill for the body of the Tip-Loc Bushing (47-00XX-S), insert the FFN Near Cortex Drill (80-3696) through the cannula within the Tip-Loc Clamp and drill under power until it bottoms out with the back of the cannula (Figures 24 and 25).

Remove the FFN Near Cortex Drill and insert the FFN Far Cortex Drill (80-3697) through the cannula within the Tip-Loc Clamp. Drill the 2 mm trocar tip through the far cortex and ream the inside region of the far cortex with the FFN Far Cortex Drill (Figures 26 and 27).

The proper Tip-Loc Bushing length is determined when the FFN Far Cortex Drill laser marks are flush against the back of the cannula within the Tip-Loc Clamp. The Tip-Loc Bushings are available in lengths ranging from 6 mm–16 mm, with 1 mm increments.

The correct bushing length can also be identified under fluoroscopy by identifying where the notches on the Far Cortex Drill are in relation to the near cortex. The notches are 2 mm apart and correspond to the associated Tip-Loc Bushing sizes. The most distal notch, closest to the drill tip, corresponds to the 6 mm Tip-Loc Bushing size and so on.

Figure 24



Figure 25

Fibula Nail 2 Surgical Technique [continued]



Figure 26

Figure 27

Tip-Loc™ Bushing & Set Screw	Part number
Tip-Loc Bushing & Set Screw Kit, 6 mm	47-0006-S
Tip-Loc Bushing & Set Screw Kit, 7 mm	47-0007-S
Tip-Loc Bushing & Set Screw Kit, 8 mm	47-0008-S
Tip-Loc Bushing & Set Screw Kit, 9 mm	47-0009-S
Tip-Loc Bushing & Set Screw Kit, 10 mm	47-0010-S
Tip-Loc Bushing & Set Screw Kit, 11 mm	47-0011-S
Tip-Loc Bushing & Set Screw Kit, 12 mm	47-0012-S
Tip-Loc Bushing & Set Screw Kit, 13 mm	47-0013-S
Tip-Loc Bushing & Set Screw Kit, 14 mm	47-0014-S
Tip-Loc Bushing & Set Screw Kit, 15 mm	47-0015-S
Tip-Loc Bushing & Set Screw Kit, 16 mm	47-0016-S

Note: The FFN Far Cortex Drill (80-3697) has a trocar tip designed to drill through the far cortex, but the transition to the larger diameter is designed to be blunt without sharp cutting features. This will provide a hard stop when the trocar tip reaches the far cortex, indicating that the surgeon has drilled far enough to allow some reaming to prepare the inside canal for the bushing.

Caution: Take care not to penetrate the far cortex with the FFN Far Cortex Drill.

Note: If needed, a Cortex Awl w/Quick Release (80-3795) can be attached to the Quick Release T-Handle (MS-T1212) and inserted by hand through the cannula within the Tip-Loc Clamp (80-3891) to further clear the site for the bushing.

Note: If the Tip-Loc Bushing measurement is between the 2 mm sizing increments, select the larger of the two sizes. The intention of the Tip-Loc Bushing is to achieve bicortical fixation within the fibula.

Fibula Nail 2 Surgical Technique [continued]

Figure 28



9D Optional Tip-Loc™ Bushing Insertion

To attach the selected Tip-Loc Bushing (47-00XX-S), place the Tip-Loc Coupler Attachment (80-2484) through the Tip-Loc Bushing Coupler Handle (80-2483). Thread the selected length Tip-Loc Bushing onto the end of the threaded Tip-Loc Bushing Coupler Handle and ensure that the bushing recess notches engage with the notches in the Tip-Loc Coupler Attachment (Figure 28).

Figure 29

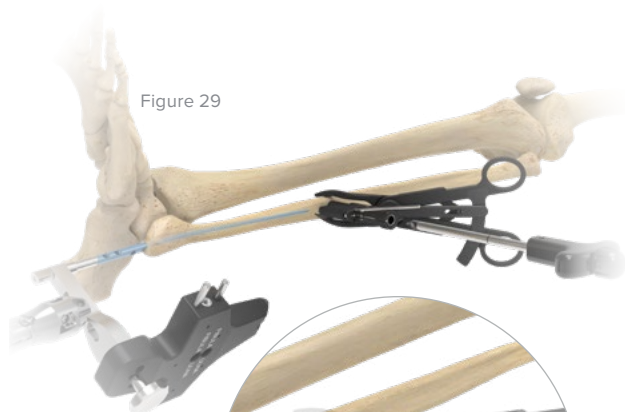

Place the Tip-Loc Bushing Coupler Driver and attached bushing through the cannula within the Tip-Loc Clamp (Figure 29). Thread the Tip-Loc Bushing into the bone until the marking on the Tip-Loc Coupler shaft is flush with the back of the cannula within the Tip-Loc Clamp (Figure 30). Depending on bone quality, the surgeon may feel a semi-solid end stop when the bushing reaches the far cortex.

Figure 30



Align the Tip-Loc Bushing Coupler Handle so that the flat surfaces are parallel with the fibula nail. This will orient the opening of the Tip-Loc Bushing towards the tip of the fibula nail.

Advance the fibula nail to the correct depth and through the Tip-Loc Bushing. Rotate the Tip-Loc Bushing Coupler Handle in either direction to help the bushing properly accept the nail tip (Figure 31).

Figure 31



Note: There is a small offset “kick” in the most distal 9.5 mm of the nail to assist in targeting and advancing the nail tip through the bushing. If the nail tip is not easily advancing through the bushing, the Fibula Nail and FFN Base Plate (80-2448) can be rotated to take advantage of the kick to align the very tip of the nail with the bushing opening.

Note: If the nail fails to advance through the bushing opening, the nail tip kick can be manually increased during surgery to create a bigger offset.

Disengage the Tip-Loc Coupler Attachment from the Tip-Loc Bushing by rotating it counterclockwise, but leave the coupler handle in place to aid in set screw insertion.

Note: It is recommended to assess the successful insertion of the nail through the bushing by taking an oblique view fluoroscopic image and also rotating the coupler handle. The nail has not advanced through the Tip-Loc Bushing if the handle can rotate more than 45 degrees in either direction (Figure 32). In this case retract the nail and use the technique described above to advance the nail through the bushing opening.

Figure 32

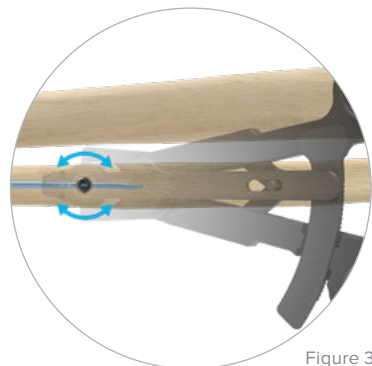

Fibula Nail 2 Surgical Technique [continued]

Note: It is recommended to insert the remaining 3.5 mm Nonlocking Hexalobe Screws (30-02XX) and 3.5 mm Headless Hexalobe Screws (3018-470XX) PRIOR to placing the Tip-Loc™ Bushing Set Screw in Step 12B to ensure all screw trajectories are correct and adjustments have been made for rotation and length. However, the surgeon may choose to lock the tip at this point to allow for compression of the fracture site by pulling on the nail attachment. To lock the tip with the set screw, proceed to step 12B. Ensure that bone alignment and screw trajectories are correct before locking the bushing and set screw.



Figure 33

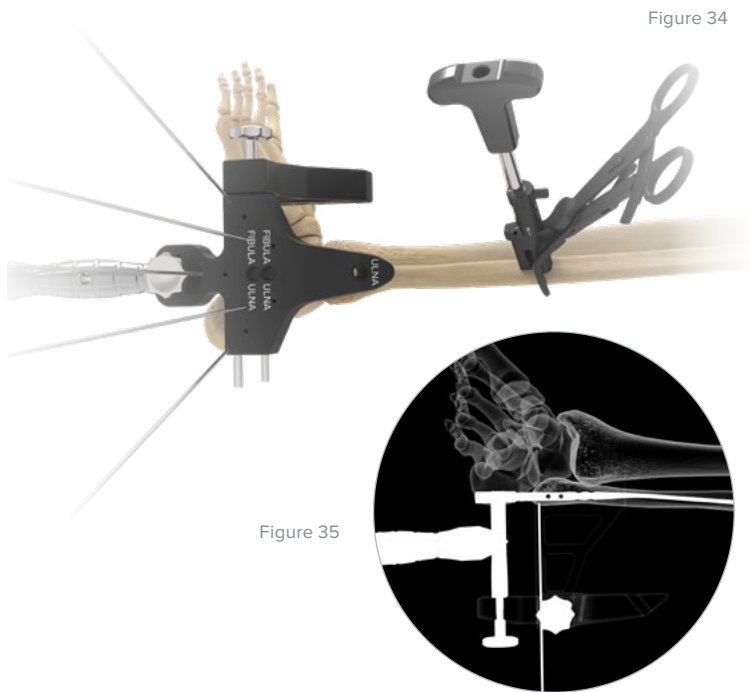

Figure 34

10 Secondary Targeting Guide for Anterior/Posterior Screws

To place A/P screws, attach the FFN Secondary Targeting Guide (80-2456) by sliding it over the extended posts on the FFN Primary Targeting Guide (80-2454). Secure the FFN Secondary Targeting Guide onto the FFN Primary Targeting Guide with an FFN Locking Knob (80-2499) (Figure 33).

The entire targeting guide construct can be provisionally secured to the bone by inserting guide wires into any of the K-wire holes in the FFN Primary Targeting Guide (Figure 34). The center most distal K-wire hole indicates where the junction of the locking bolt and nail tail meet (Figure 35).

Figure 35



Fibula Nail 2 Surgical Technique [continued]

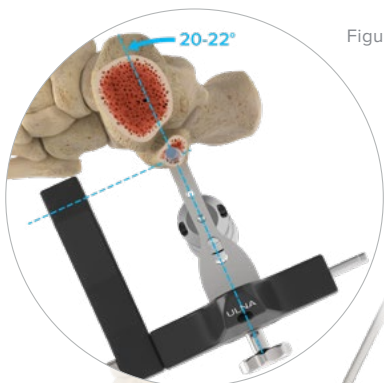

Figure 36

11 Anterior/Posterior Screw Placement

It is recommended to implant at least one A/P screw. Prior to A/P screw placement, and only if implanting an L/M screw for syndesmosis fixation, ensure the L/M screw is angled 20–22 degrees anterior in order to target the syndesmosis by rotating the nail to meet the correct angle (Figure 36).

To implant an A/P screw, place the FFN 3.5 mm Cannula (80-2476) through the holes of the FFN Secondary Targeting Guide (80-2456) labeled "Fibula."

Make a small stab incision where the FFN 3.5 mm Cannula meets the skin, then advance the cannula until it rests against the bone. Insert the FFN 2.8 mm Drill Guide (80-2505) into the FFN 3.5 mm Cannula (Figure 37).

Use the FFN 2.8 mm Drill (80-2471) through the FFN 2.8 mm Drill Guide, drilling through at least one cortex (Figure 38).

Once the desired depth is achieved, read the laser marks on the drill as it aligns with the back of the FFN 2.8 mm Drill Guide to select the appropriate screw length (Figure 39). Choose from either a 3.5 mm Nonlocking Screw (30-02XX) or 3.5 mm Headless Hexalobe Screw (3018-470XX). Remove the FFN 2.8 mm Drill Guide and place the selected screw with the FFN T15 Hexalobe Driver (80-3619) and the Medium Ratcheting Driver Handle (80-0663) (Figure 42). Take care not to over-torque the screw.

Repeat the steps above if a second A/P screw if desired. The FFN Secondary Targeting Guide can be removed once the desired number of A/P screws have been implanted. Check for proper screw placement under fluoroscopy.

Figure 37

Figure 38

Figure 39

Fibula Nail 2 Surgical Technique [continued]



Figure 40

Note: The FFN Depth Gauge (80-2468) can be used in place of the laser marks on the FFN 2.8 mm Drill to identify screw lengths (Figures 40 and 41).

Note: It may be necessary to subtract 2 mm from the identified length when using a 3.5 mm Headless Hexalobe Screw or when drilling at an angle, depending on the final seating depth of the screw within the bone.



Figure 41

Note: An FFN Headless Screw Countersink (80-3769) is available for the 3.5 mm Headless Hexalobe Screws if needed.



Figure 42

Fibula Nail 2 Surgical Technique [continued]

Figure 43



Figure 44

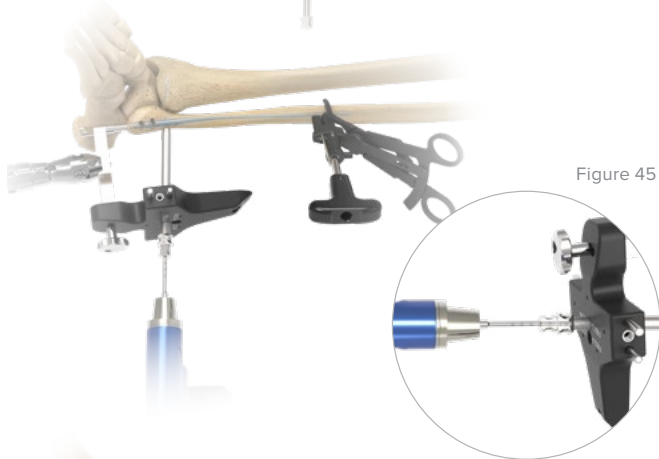

Figure 45



Figure 46



Figure 47



12 Lateral/Medial Screw Placement

It is recommended to implant at least one L/M screw. If utilizing the L/M screws for syndesmotic fixation, insert the distal of the two L/M screws first to ensure the correct height above the joint line. In larger patients, the nail may need to be inserted deeper within the metaphysis so that the L/M screws can clear the tibial plafond. To ensure the distal end of the nail still provides cortical support, an optional end cap can be used to extend the overall nail length. The primary targeting guide assembly may be rotated slightly when placing screws across the syndesmosis.

Note: The proximal screw hole is threaded and the distal screw hole is non-threaded.

Warning: The Acu-Sinch® Knotless can only be utilized in the distal non-threaded L/M hole. Refer to the necessary Acu-Sinch Knotless technique steps on page 26.

To implant a L/M screw, place the FFN 3.5 mm Cannula (80-2476) through the holes of the FFN Primary Targeting Guide (80-2454) labeled "Fibula."

Make a small stab incision where the FFN 3.5 mm Cannula meets the skin, then advance the FFN 3.5 mm Cannula until it rests against the bone. Insert the FFN 2.8 mm Drill Guide (80-2505) into the FFN 3.5 mm Cannula (Figure 43). Use the 2.8 mm Drill (80-2471) through the FFN 2.8 mm Drill Guide, drilling through at least one cortex (Figure 44). Once the desired depth is achieved, read the laser marks on the drill as it aligns with the back of the FFN 2.8 mm Drill Guide to select the appropriate screw length (Figure 45 and 46).

Choose from either a 3.5 mm Nonlocking Hexalobe Screw (80-03XX) or 3.5 mm Headless Hexalobe Screw (3018-470XX). Remove the FFN 2.8 mm Drill Guide and insert the selected screw using the FFN T15 Hexalobe Driver (80-3619) and the Medium Ratcheting Driver Handle (80-0663) (Figure 47). Take care not to over-torque the screw.

Repeat the steps above if a second L/M screw is desired. The FFN Primary Targeting Guide can be removed once the desired number of L/M screws have been implanted. Check for proper screw placement under fluoroscopy.

Note: The FFN Depth Gauge (80-2468) can be used in place of the laser marks on the FFN 2.8 mm Drill to identify screw lengths.

Note: It may be necessary to subtract 2 mm from the identified length when using a 3.5 mm Headless Hexalobe Screw or when drilling at an angle, depending on the final seating depth of the screw within the bone.

Note: An FFN Headless Screw Countersink (80-3769) is available for the 3.5 mm Headless Hexalobe Screws if needed.

Fibula Nail 2 Surgical Technique [continued]



Figure 48



Figure 49



Figure 50

Figure 51



Figure 52

12A Optional End Cap Placement

End caps can be utilized to extend the nail length and may assist in removal by protecting the nail threading from bony ongrowth.

Use the notches on the barrel of the FFN Base Plate (80-2448) at the tail of the nail to identify the correct end cap length.

Disengage the FFN Locking Bolt (80-2452) from the fibula nail using either the slots within FFN Handle (80-3885) or the FFN T15 Hexalobe Driver (80-3619).

Attach the desired FFN End Cap (4014-0XXX) to the appropriate Hexalobe Driver Tip found in the table below:

Hexalobe Driver Size	FFN End Cap Sizes
T8 Hexalobe Driver (80-2895)	FFN +.4 mm End Cap (4014-0600)
T15 Hexalobe Driver (80-3619)	FFN +5 mm End Cap (4014-0705)
T15 Hexalobe Driver (80-3619)	FFN +10 mm End Cap (4014-0710)
T15 Hexalobe Driver (80-3619)	FFN +15 mm End Cap (4014-0715)

Thread the end cap into the tail of the nail using the associated driver tip and the Medium Ratcheting Driver Handle (80-0663) (Figure 48).

Ensure the nail tail and FFN End Cap construct are not left proud in the bone (Figure 49).

12B Optional Tip-Loc™ Set Screw

Before locking down the tip of the nail, ensure the fracture is well reduced and the placement of the screws is correct.

Insert the Tip-Loc Set Screw (3017-250XX) that corresponds to the FFN Bushing, using the FFN T8 Hexalobe Driver (80-2895) with the Medium Ratcheting Driver Handle (80-0663), through the coupler handle shaft into the bushing; tighten the set screw until a solid stop is felt (Figure 50). The groove at the tail end of the driver lines up with the end of the handle when the bushing is fully inserted and the set screw is flush with the bushing (Figure 51).

Caution: Do not use the Quick Release T-Handle (MS-T1212) to implant the Tip-Loc Bushing Set Screw as this can provide too much torque (Figure 52).

Fibula Nail 2 Surgical Technique [continued]

13 Optional Tip-Loc™ Clamp Removal

With the Tip-Loc Set Screw engaged, remove the Tip-Loc Bushing Coupler Handle (80-2483) from the cannula within the Tip-Loc Clamp (Figure 53).

Remove any of the 2.0 mm Short Guide Wires (35-0023) that may have been placed through the Tip-Loc Clamp.

Disengage the Tip-Loc Clamps jaws from the fibula and remove from the incision site (Figures 54 and 55).

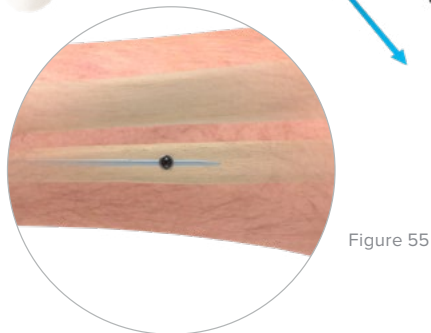
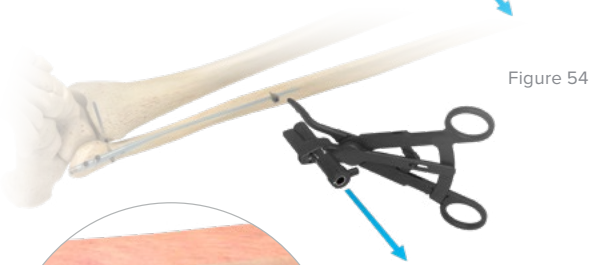

14 Closure

With the nail construct implanted and the targeting guides removed, begin closure of the incisions based on the surgeon's preferred method (Figure 56).

Fibula Nail 2 Removal Surgical Technique

Figure 1

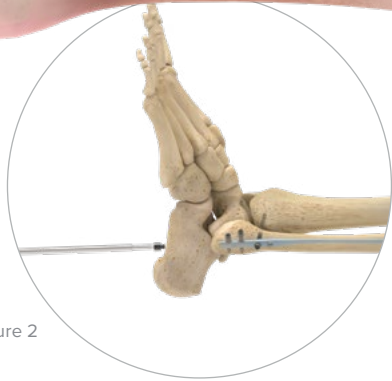
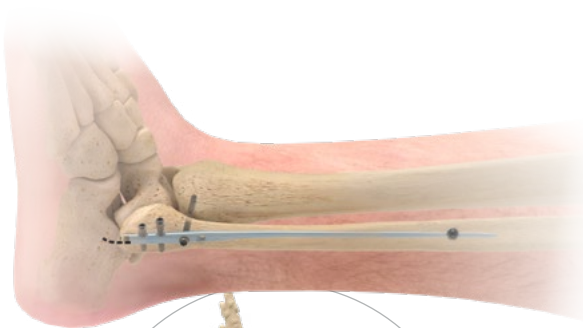

Figure 2

Confirm the overall nail construct under fluoroscopy. Be sure to check the location of screws and if there are optional end caps or an optional Tip-Loc™ Bushing and Set Screw implanted.

1 Removal of Optional End Cap

Expose the distal end of the implant as confirmed under fluoroscopy (Figure 1). Drill toward the distal fibula implant tip to create a path for the nail to exit. Then using curettes, rongeurs, osteotomes, or a combination, open the canal so the distal end of the nail is freely accessible.

If an end cap is present, it must be removed before the nail can be explanted (Figure 2).

If the end cap is the +5 mm, +10 mm, or +15 mm size (4014-0705, 4014-0710, 4014-0715), use the FFN T15 Hexalobe Driver (80-3619) and a Medium Ratcheting Driver Handle (80-0663) to remove the end cap from the nail.

If the end cap is +.4 mm FFN End Cap (4014-0600), which is flush with the nail, use the FFN T8 Hexalobe Driver (80-2895) and a Medium Ratcheting Driver Handle (80-0663) to remove the end cap from the nail.

Note: For the +5, +10, and +15 End Caps (4014-07XX), the 3.0 mm Easyout, QR (80-0601) can be used if the T15 Hexalobe Driver does not engage the end cap fully. For the +.4 mm End Cap (4014-0600), the 2.0 mm Easyout, QR (80-0599) can be used if the FFN T8 Hexalobe Driver does not engage the end cap fully.

2 Screw Removal

The most distal A/P screw should be removed first. Confirm the distal screw location(s) under fluoroscopy and use a standard soft-tissue dissection method to expose the screw head(s). Use the FFN T15 Hexalobe Driver (80-3619) and the Medium Ratcheting Driver Handle (80-0663) to remove the screw (Figure 3).

Before removing additional screws, insert the FFN Bolt (80-3886) into the threaded back end of the nail (Figure 4). Use the same technique as described above to remove any additional screws (Figure 5). Under fluoroscopy, ensure no screws are still engaged in the nail prior to nail removal.

Note: Removal of soft-tissue or bony ongrowth may be necessary. Using a Sharp Hook (PL-CL06) may aid in this removal.

Note: The 3.0 mm Easyout, QR (80-0601) can be used to remove the nail if the FFN Bolt does not fully engage.

Note: It is recommended to engage the Tip-Loc Coupler Attachment through the Tip-Loc Bushing Coupler Handle with the nail in place to provide more stability (Figure 7).

Figure 3

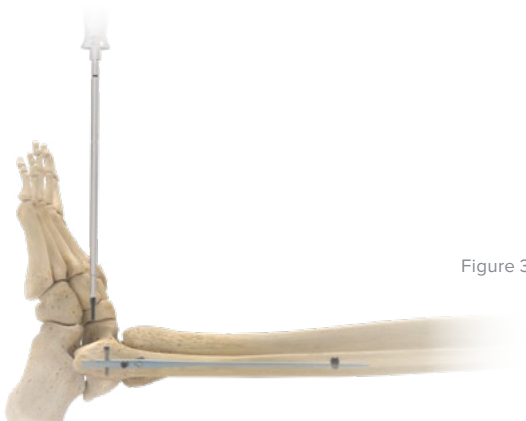

Figure 4

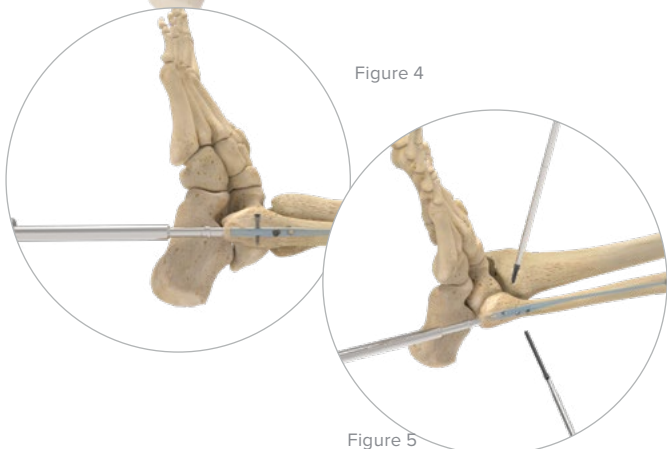

Figure 5

Fibula Nail 2 Removal Surgical Technique [continued]

Figure 6



3 Removal of Optional Tip-Loc™ Set Screw

Identify the Tip-Loc Bushing and Set Screw under fluoroscopy and mark the skin as the center point for an incision to expose the bushing and set screw.

To remove the Tip-Loc Set Screw (47-000X-S), connect the FFN T8 Hexalobe Driver (80-2895) to the Medium Ratcheting Driver Handle (80-0663) and disengage the set screw by turning counterclock wise (Figure 6).

Note: The nail must be removed prior to the Tip-Loc Bushing removal.

Figure 7

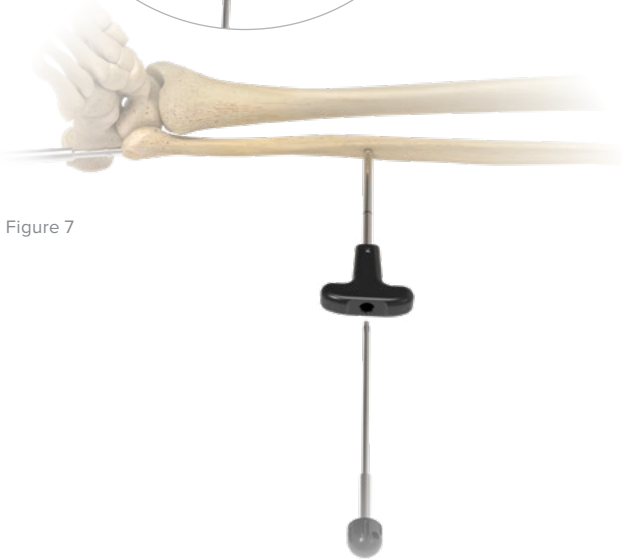

Fibula Nail 2 Removal Surgical Technique [continued]

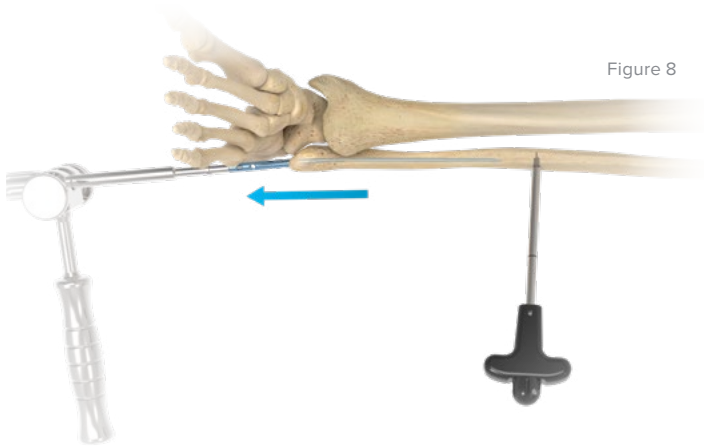

Figure 8

4 Nail Removal

With the FFN Bolt (80-3886) threaded in the end of the fibula nail (see Step 2) manually remove the nail from the canal. If additional force is needed, use the FFN Multiple Contact Hammer (80-3966) to backslap on the FFN Bolt to remove the nail (Figure 8).



Figure 9

5 Optional Tip-Loc™ Bushing Removal

To remove the Tip-Loc Bushing, insert the Tip-Loc Coupler Attachment (80-2484) through the Tip-Loc Bushing Coupler Handle (80-2483) and remove the bushing from the bone (Figure 9).

Note: The 3.0 mm Easyout, QR (80-0601) can be used to remove the Tip-Loc Bushing if the Tip-Loc Coupler Attachment and Tip-Loc Bushing Coupler Handle do not fully engage.

Caution: Removal of the optional Tip-Loc Bushing may increase the risk of bone fracture

Acu-Sinch® Knotless Ankle Syndesmosis Repair System Nail Surgical Technique

Fibula Nail 2

1 Reduction

Syndesmotic reduction either open or closed, should ensure the distal fibula is out to length and anatomically reduced within the tibia incisura as viewed in the A/P and lateral X-rays. Accurate restoration of the anatomic relationship between the distal fibula and tibia is critical. Once anatomic length, rotation, and alignment of the fibula fracture have been established and the fracture stabilized with the Fibula Nail 2, syndesmotic reduction can proceed using an Acu-Sinch® Knotless System w/Inserter 3.5 mm Kit (46-0023-S) in the distal of the two L/M holes.

Note: Acu-Sinch Knotless must be utilized in the most distal of the two L/M holes in the Fibula Nail 2. This hole is unthreaded and will properly accept the Acu-Sinch Knotless drill and inserter handle.

2 Drill

Prior to drilling, ensure the distal L/M hole is at the correct height above the joint line, approximately 1–2 cm above the tibial plafond. Insert the FFN ASK 3.5 mm Drill Guide (80-4210) into the FFN 3.5 mm Cannula (80-2476) and place both into the distal of the two L/M holes in the FFN Primary Targeting Guide. Make a small stab incision so the FFN 3.5 mm Cannula and FFN ASK 3.5 mm Drill Guide are flush against the bone prior to drilling.

Drill all four cortices through the targeting guide components with the 3.5 mm Long Drill, QC (80-4209-S).

Note: The 3.5 mm Long Drill comes in a separate sterile package.

Once drilled, remove the targeting guide components to insert the Acu-Sinch Knotless System through the selected fibula nail.

3 Device Insertion

Implant the Acu-Sinch Knotless System as described in steps 2-6 from the Ankle Syndesmosis Repair System Surgical Technique (TLB00-01).

Once the Round Button is fully seated on the plate, pull the suture loop to achieve the desired repair tension. Cut the suture limbs flush with the fibula button.

Note: The optional Acu-Sinch Washer 3.5 mm Kit (5502-0205-S) is not recommended between the Round Button and Fibula Nail 2.

Figure 1

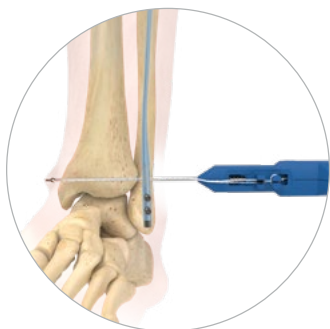
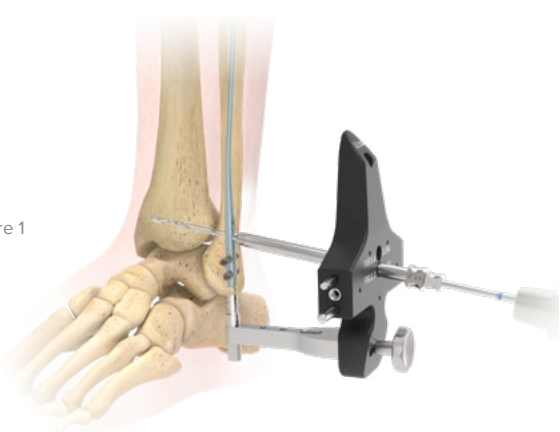
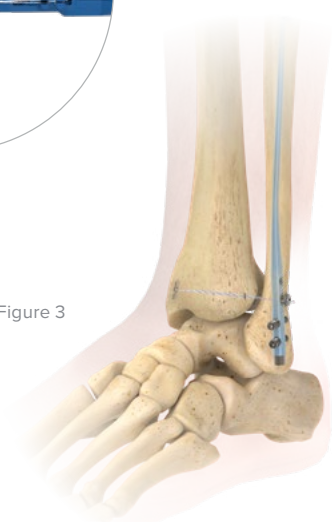
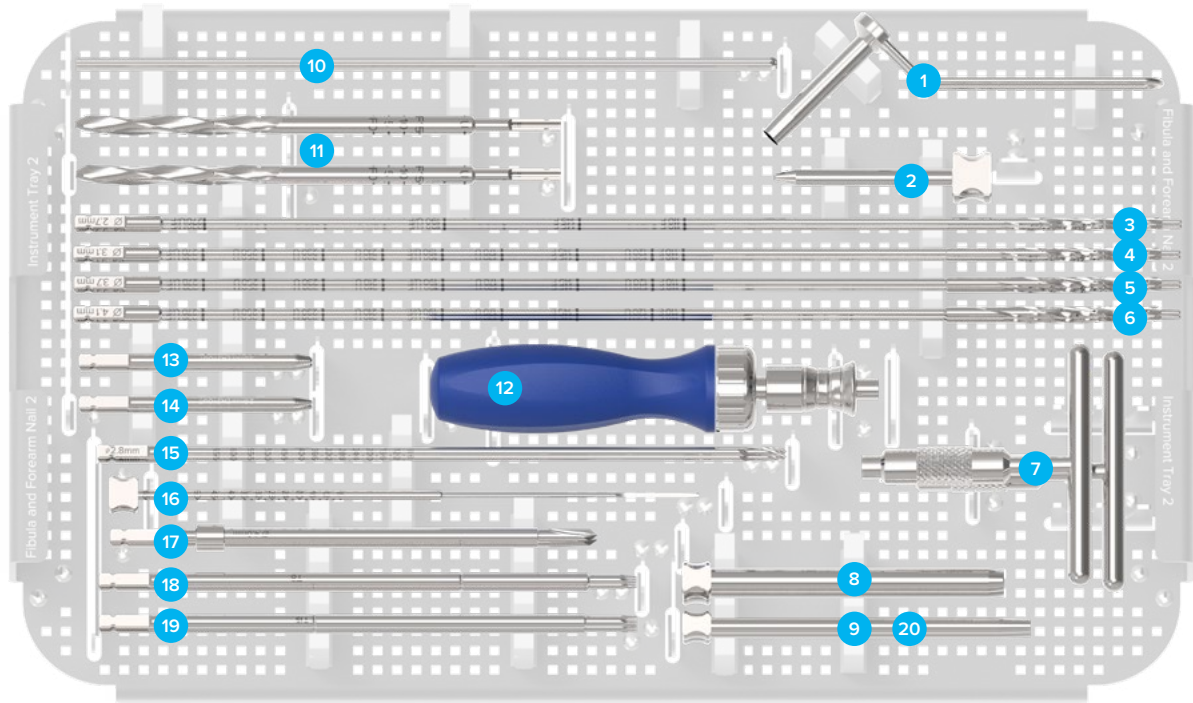

Figure 2

Figure 3



Ordering Information



Tray Components

Instrumentation

1	FFN Soft-Tissue Protector	80-2896	10	2.0 mm x 9" ST Guide Wire	WS-2009ST
2	FFN Guide Wire Probe	80-2900	11	FFN 6.5 mm Drill	80-4039
3	FFN 2.7 mm Reamer	80-2459	12	Medium Ratcheting Driver Handle	80-0663
4	FFN 3.1 mm Reamer	80-2460	13	2.0 mm Easyout, QR	80-0599
5	FFN 3.7 mm Reamer	80-2461	14	3.0 mm Easyout, QR	80-0601
6	FFN 4.1 mm Reamer	80-2462	15	FFN 2.8 mm Drill	80-2471
7	Quick Release T-Handle	MS-T1212	16	FFN Depth Gauge	80-2468
8	FFN 3.5 mm Cannula	80-2476	17	FFN Headless Screw Countersink	80-3769
9	FFN 2.8 mm Drill Guide	80-2505	18	FFN T8 Hexalobe Driver	80-2895
			19	FFN T15 Hexalobe Driver	80-3619

Sterile Tray Components

Instrumentation

FFN 6.5 mm Drill	80-4039-S	FFN 2.8 mm Drill	80-2471-S
2.0 mm x 9" ST Guide Wire	WS-2009ST-S	FFN Headless Screw Countersink	80-3769-S

Optional Acu-Sinch® Knotless Instrumentation

20	FFN ASK 3.5 mm Drill Guide	80-4210
----	----------------------------	---------

Ordering Information [continued]

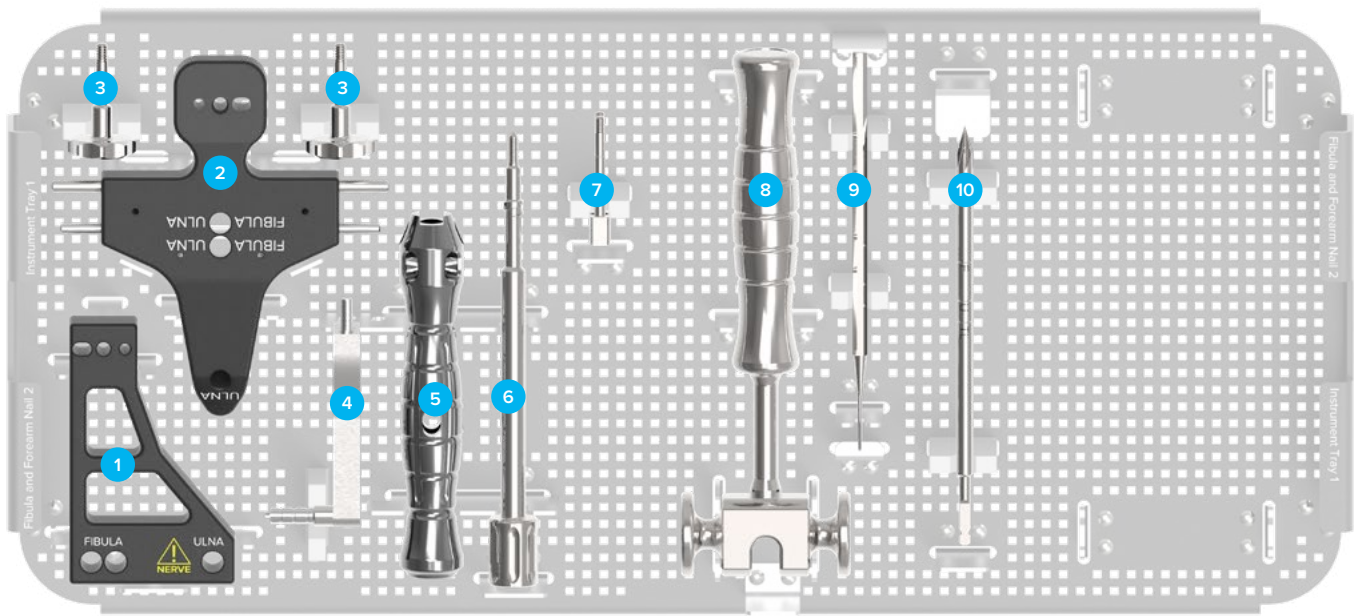

Tray Components

Instrumentation

1	FFN Secondary Targeting Guide	80-2456	6	FFN Bolt	80-3886
2	FFN Primary Targeting Guide	80-2454	7	FFN Locking Bolt	80-2452
3	FFN Locking Knob	80-2499	8	FFN Multiple Contact Hammer	80-3966
4	FFN Base Plate	80-2448	9	Sharp Hook	PL-CL06
5	FFN Handle	80-3885	10	Cortex Awl w/Quick Release	80-3795

Sterile Tray Components

Instrumentation

Cortex Awl w/Quick Release	80-3795-S
----------------------------	-----------

Ordering Information [continued]

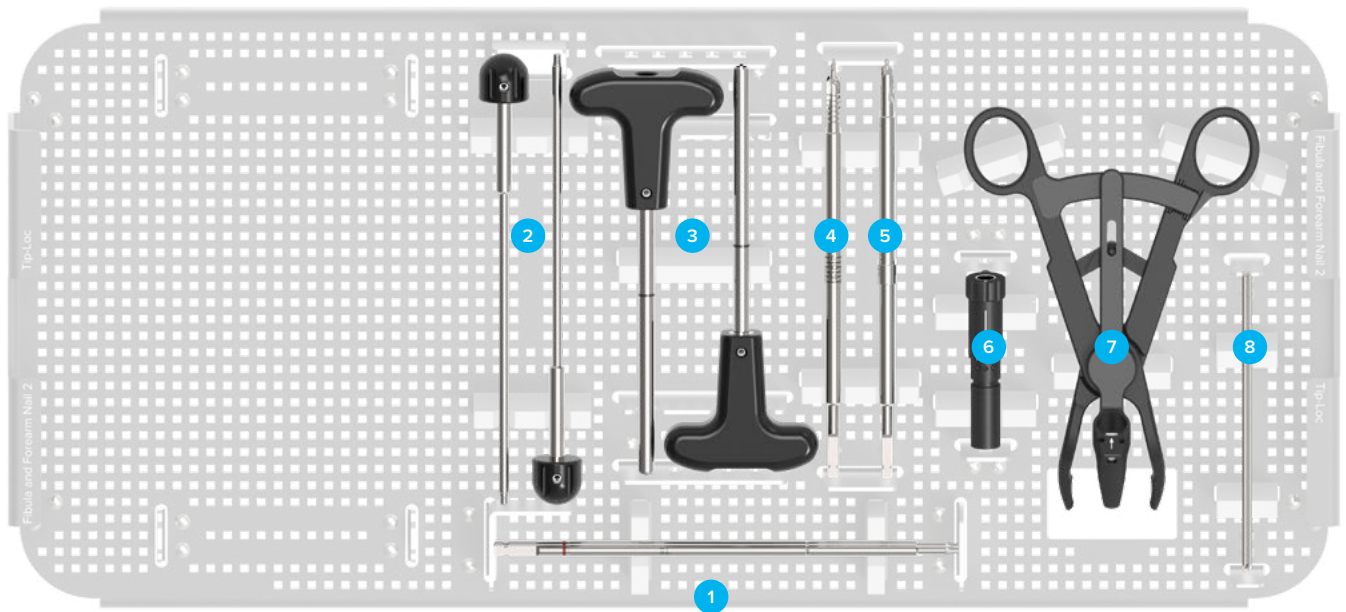

Tray Components

Instrumentation

1	FFN T8 Hexalobe Driver	80-2895	5	FFN Near Cortex Drill	80-3696
2	Tip-Loc™ Coupler Attachment	80-2484	6	Tip-Loc Clamp Rotary Cannula	80-3760
3	Tip-Loc Bushing Coupler Handle	80-2483	7	Tip-Loc Clamp	80-3891
4	FFN Far Cortex Drill	80-3697	8	2.0 mm Short Guide Wire	35-0023

Sterile Tray Components

Instrumentation

FFN Far Cortex Drill	80-3697-S
FFN Near Cortex Drill	80-3696-S
2.0 mm Short Guide Wire	35-0023-S

Optional Acu-Sinch® Knotless Ankle Syndesmosis Repair System

Acu-Sinch Knotless System w/Inserter 3.5 mm Kit	46-0023-S
---	-----------

Acu-Sinch Knotless System w/ Inserter 3.5 mm	46-0024-S
--	-----------

Optional Acu-Sinch Knotless Instrumentation

3.5 mm Long Drill, QC	80-4209-S
-----------------------	-----------

FFN ASK 3.5 mm Drill Guide	80-4210
----------------------------	---------

Ordering Information [continued]

Tray Components		
1 3.5 mm Nonlocking Hexalobe Screws		
3.5 mm x 8 mm Nonlocking Hexalobe Screw	30-0255	
3.5 mm x 10 mm Nonlocking Hexalobe Screw	30-0256	
3.5 mm x 12 mm Nonlocking Hexalobe Screw	30-0257	
3.5 mm x 14 mm Nonlocking Hexalobe Screw	30-0258	
3.5 mm x 16 mm Nonlocking Hexalobe Screw	30-0259	
3.5 mm x 18 mm Nonlocking Hexalobe Screw	30-0260	
3.5 mm x 20 mm Nonlocking Hexalobe Screw	30-0261	
3.5 mm x 22 mm Nonlocking Hexalobe Screw	30-0262	
3.5 mm x 24 mm Nonlocking Hexalobe Screw	30-0263	
3.5 mm x 26 mm Nonlocking Hexalobe Screw	30-0264	
3.5 mm x 28 mm Nonlocking Hexalobe Screw	30-0265	
3.5 mm x 30 mm Nonlocking Hexalobe Screw	30-0266	
3.5 mm x 32 mm Nonlocking Hexalobe Screw	30-0267	
3.5 mm x 34 mm Nonlocking Hexalobe Screw	30-0268	
3.5 mm x 36 mm Nonlocking Hexalobe Screw	30-0269	
3.5 mm x 38 mm Nonlocking Hexalobe Screw	30-0270	
3.5 mm x 40 mm Nonlocking Hexalobe Screw	30-0271	
3.5 mm x 45 mm Nonlocking Hexalobe Screw	30-0272	
3.5 mm x 50 mm Nonlocking Hexalobe Screw	30-0273	
3.5 mm x 55 mm Nonlocking Hexalobe Screw	30-0274	
3.5 mm x 60 mm Nonlocking Hexalobe Screw	30-0275	
3.5 mm x 65 mm Nonlocking Hexalobe Screw	30-0276	
2 3.5 mm Headless Hexalobe Screws		
3.5 mm x 12 mm Headless Hexalobe Screw		3018-47012
3.5 mm x 14 mm Headless Hexalobe Screw		3018-47014
3.5 mm x 16 mm Headless Hexalobe Screw		3018-47016
3.5 mm x 18 mm Headless Hexalobe Screw		3018-47018
3.5 mm x 20 mm Headless Hexalobe Screw		3018-47020
3.5 mm x 22 mm Headless Hexalobe Screw		3018-47022
3.5 mm x 24 mm Headless Hexalobe Screw		3018-47024
3.5 mm x 26 mm Headless Hexalobe Screw		3018-47026
3.5 mm x 28 mm Headless Hexalobe Screw		3018-47028
3.5 mm x 30 mm Headless Hexalobe Screw		3018-47030
3.5 mm x 32 mm Headless Hexalobe Screw		3018-47032
3.5 mm x 34 mm Headless Hexalobe Screw		3018-47034
3.5 mm x 36 mm Headless Hexalobe Screw		3018-47036
3.5 mm x 38 mm Headless Hexalobe Screw		3018-47038
3.5 mm x 40 mm Headless Hexalobe Screw		3018-47040
3.5 mm x 45 mm Headless Hexalobe Screw		3018-47045
3.5 mm x 50 mm Headless Hexalobe Screw		3018-47050
3.5 mm x 55 mm Headless Hexalobe Screw		3018-47055
3.5 mm x 60 mm Headless Hexalobe Screw		3018-47060
3.5 mm x 65 mm Headless Hexalobe Screw		3018-47065
3 FFN End Caps		
FFN +0.4 mm End Cap		4014-0600
FFN +5 mm End Cap		4014-0705
FFN +10 mm End Cap		4014-0710
FFN +15 mm End Cap		4014-0715

Ordering Information

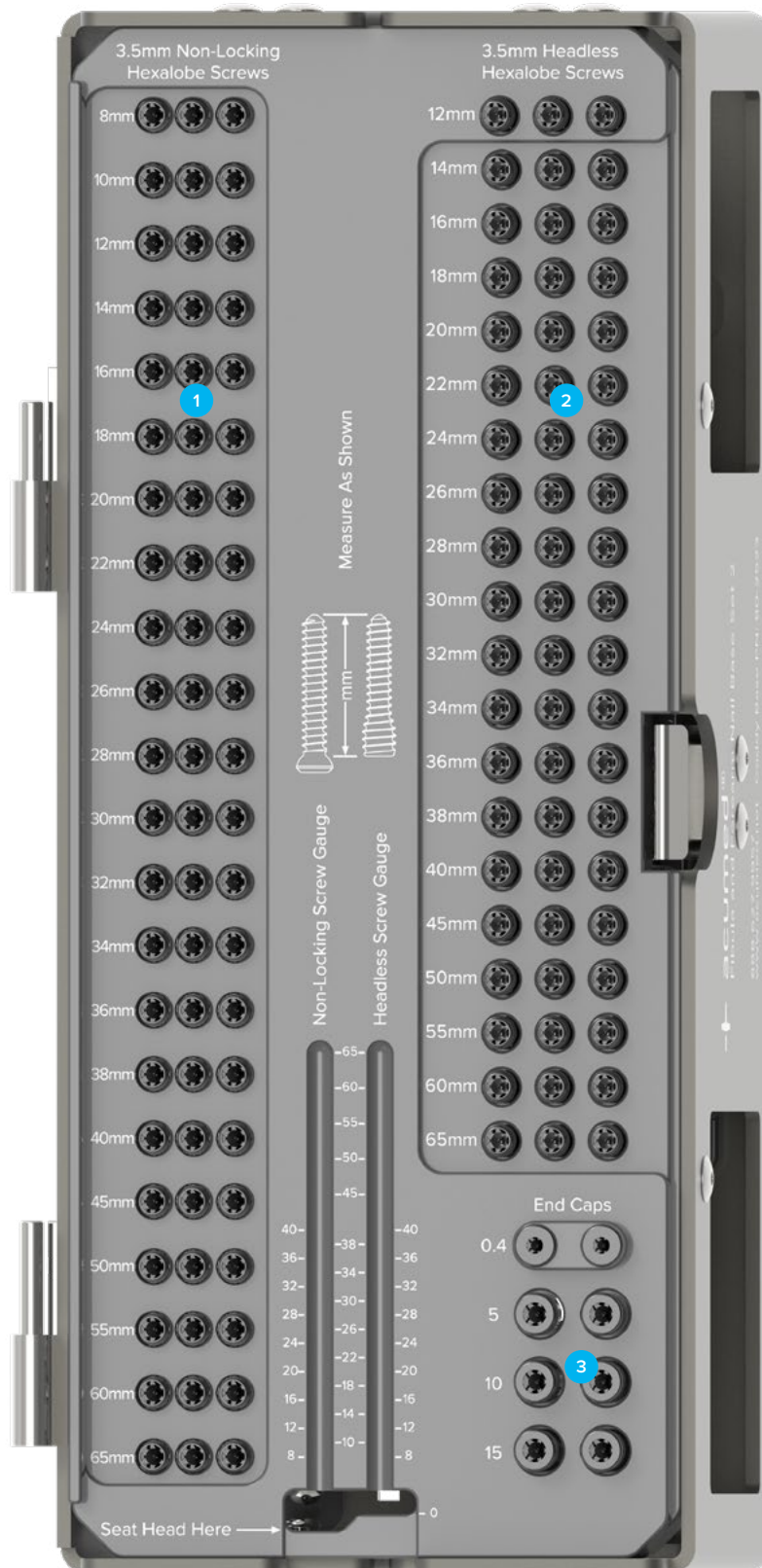

Ordering Information [continued]

Sterile Implants			
2.6 mm Fibula Nails		Tip-Loc™ Bushing & Set Screw Kit	
2.6 mm x 110 mm Fibula Nail 2	4010-2611N-S	Tip-Loc Bushing & Set Screw Kit, 6 mm	47-0006-S
2.6 mm x 145 mm Fibula Nail 2	4010-2614N-S	Tip-Loc Bushing & Set Screw Kit, 7 mm	47-0007-S
2.6 mm x 190 mm Fibula Nail 2	4010-2619N-S	Tip-Loc Bushing & Set Screw Kit, 8 mm	47-0008-S
2.6 mm x 270 mm Fibula Nail 2	4010-2627N-S	Tip-Loc Bushing & Set Screw Kit, 9 mm	47-0009-S
3.0 mm Fibula Nails		Tip-Loc Bushing & Set Screw Kit, 10 mm	47-0010-S
3.0 mm x 110 mm Fibula Nail 2	4010-3011N-S	Tip-Loc Bushing & Set Screw Kit, 11 mm	47-0011-S
3.0 mm x 145 mm Fibula Nail 2	4010-3014N-S	Tip-Loc Bushing & Set Screw Kit, 12 mm	47-0012-S
3.0 mm x 190 mm Fibula Nail 2	4010-3019N-S	Tip-Loc Bushing & Set Screw Kit, 13 mm	47-0013-S
3.0 mm x 270 mm Fibula Nail 2	4010-3027N-S	Tip-Loc Bushing & Set Screw Kit, 14 mm	47-0014-S
3.6 mm Fibula Nails		Tip-Loc Bushing & Set Screw Kit, 15 mm	47-0015-S
3.6 mm x 110 mm Fibula Nail 2	4010-3611N-S	Tip-Loc Bushing & Set Screw Kit, 16 mm	47-0016-S
3.6 mm x 145 mm Fibula Nail 2	4010-3614N-S		
3.6 mm x 190 mm Fibula Nail 2	4010-3619N-S		
3.6 mm x 270 mm Fibula Nail 2	4010-3627N-S		
Trays & Caddies			
FFN 2 Base Set Case Base	80-2521	FFN 2 Base Set Tip-Loc Case Lid	80-3947
FFN 2 Base Set Case Lid	80-2522	FFN 2 Base Set with Tip-Loc Case Base	80-3948
FFN 2 Base Set Tray 2	80-2524	FFN 2 Base Set Caddy Base	80-2523
FFN 2 Base Set Tray 3	80-2719	FFN 2 Base Set Caddy Lid	80-3480
FFN 2 Base Set Tray 1	80-3945	FFN 2 Base Set with Tip-Loc Case Lid	80-3949
FFN 2 Base Set Tip-Loc Case Base	80-3946	FFN 2 Base Set SS Tray 1 Assembly	80-4062
		FFN 2 Base Set SS Tray 2 Assembly	80-4064
		SS Tray Lid	80-4068

Note: To learn more about the full line of Acumed innovative surgical solutions, please contact your authorized Acumed distributor, call 888.627.9957, or visit www.acumed.net.

Ordering Information [continued]

Sterile Tray Components	
3.5 mm Nonlocking Hexalobe Screws	
3.5 mm x 8 mm Nonlocking Hexalobe Screw	30-0255-S
3.5 mm x 10 mm Nonlocking Hexalobe Screw	30-0256-S
3.5 mm x 12 mm Nonlocking Hexalobe Screw	30-0257-S
3.5 mm x 14 mm Nonlocking Hexalobe Screw	30-0258-S
3.5 mm x 16 mm Nonlocking Hexalobe Screw	30-0259-S
3.5 mm x 18 mm Nonlocking Hexalobe Screw	30-0260-S
3.5 mm x 20 mm Nonlocking Hexalobe Screw	30-0261-S
3.5 mm x 22 mm Nonlocking Hexalobe Screw	30-0262-S
3.5 mm x 24 mm Nonlocking Hexalobe Screw	30-0263-S
3.5 mm x 26 mm Nonlocking Hexalobe Screw	30-0264-S
3.5 mm x 28 mm Nonlocking Hexalobe Screw	30-0265-S
3.5 mm x 30 mm Nonlocking Hexalobe Screw	30-0266-S
3.5 mm x 32 mm Nonlocking Hexalobe Screw	30-0267-S
3.5 mm x 34 mm Nonlocking Hexalobe Screw	30-0268-S
3.5 mm x 36 mm Nonlocking Hexalobe Screw	30-0269-S
3.5 mm x 38 mm Nonlocking Hexalobe Screw	30-0270-S
3.5 mm x 40 mm Nonlocking Hexalobe Screw	30-0271-S
3.5 mm x 45 mm Nonlocking Hexalobe Screw	30-0272-S
3.5 mm x 50 mm Nonlocking Hexalobe Screw	30-0273-S
3.5 mm x 55 mm Nonlocking Hexalobe Screw	30-0274-S
3.5 mm x 60 mm Nonlocking Hexalobe Screw	30-0275-S
3.5 mm x 65 mm Nonlocking Hexalobe Screw	30-0276-S
3.5 mm Headless Hexalobe Screws	
3.5 mm x 12 mm Headless Hexalobe Screw	3018-47012-S
3.5 mm x 14 mm Headless Hexalobe Screw	3018-47014-S
3.5 mm x 16 mm Headless Hexalobe Screw	3018-47016-S
3.5 mm x 18 mm Headless Hexalobe Screw	3018-47018-S
3.5 mm x 20 mm Headless Hexalobe Screw	3018-47020-S
3.5 mm x 22 mm Headless Hexalobe Screw	3018-47022-S
3.5 mm x 24 mm Headless Hexalobe Screw	3018-47024-S
3.5 mm x 26 mm Headless Hexalobe Screw	3018-47026-S
3.5 mm x 28 mm Headless Hexalobe Screw	3018-47028-S
3.5 mm x 30 mm Headless Hexalobe Screw	3018-47030-S
3.5 mm x 32 mm Headless Hexalobe Screw	3018-47032-S
3.5 mm x 34 mm Headless Hexalobe Screw	3018-47034-S
3.5 mm x 36 mm Headless Hexalobe Screw	3018-47036-S
3.5 mm x 38 mm Headless Hexalobe Screw	3018-47038-S
3.5 mm x 40 mm Headless Hexalobe Screw	3018-47040-S
3.5 mm x 45 mm Headless Hexalobe Screw	3018-47045-S
3.5 mm x 50 mm Headless Hexalobe Screw	3018-47050-S
3.5 mm x 55 mm Headless Hexalobe Screw	3018-47055-S
3.5 mm x 60 mm Headless Hexalobe Screw	3018-47060-S
3.5 mm x 65 mm Headless Hexalobe Screw	3018-47065-S
FFN End Caps	
FFN +0.4 mm End Cap	4014-0600-S
FFN +5 mm End Cap	4014-0705-S
FFN +10 mm End Cap	4014-0710-S
FFN +15 mm End Cap	4014-0715-S



www.acumed.net

Acumed USA Campus
5885 NE Cornelius Pass Road
Hillsboro, OR 97124
+1.888.627.9957

OsteoMed USA Campus
3885 Arapaho Road
Addison, TX 75001
+1.800.456.7779

Acumed Iberica Campus
C. Proci3n, 1
Edificio Oficor
28023 Madrid, Spain
+34.913.51.63.57

FNA10-02-E | Effective: 2024/07 | © 2024 Acumed® LLC

These materials contain information about products that may or may not be available in any particular country or may be available under different trademarks in different countries. The products may be approved or cleared by governmental regulatory organizations for sale or use with different indications or restrictions in different countries. Products may not be approved for use in all countries. Nothing contained in these materials should be construed as a promotion or solicitation for any product or for the use of any product in a particular way that is not authorized under the laws and regulations of the country where the reader is located. Nothing in these materials should be construed as a representation or warranty as to the efficacy or quality of any product, nor the appropriateness of any product to treat any specific condition. Physicians may direct questions about the availability and use of the products described in these materials to their authorized Acumed distributor. Specific questions patients may have about the use of the products described in these materials or the appropriateness for their own conditions should be directed to their own physician.

Refer to the provided instructions for use for the complete indications, contraindications, warnings, and instructions for use.

OsteoMed LLC is a wholly owned subsidiary of Acumed LLC.
OsteoMed® is a registered trademark of OsteoMed LLC.

Acumed® and Tip-Loc™ are registered trademarks of Acumed LLC.